

# User Manual

## Double thermocouple Type K with J-Head - OH

Article no.805017 1211



HP / CK 25.06.2024

All rights reserved. Changes to the documents are not allowed. Please read the operating instructions before starting any work and keep them carefully and to hand.

### Testo Sensor GmbH

Testo-Straße 1  
D-79853 Lenzkirch

+49 7653 96597-71  
webshop@testo-sensor.de

Managing Director: Prof. Burkart Knospe, Martin Arndt, Timo Löffler  
Amtsgericht Freiburg HRB 706025 | Umsatzsteuer-ID.: DE274417683  
Please find our whole temperature probe and transmitter portfolio in our webshop at: [www.testo-sensor.shop](http://www.testo-sensor.shop)

# 1. Table of content

- 1. General ..... 3
  - 1.1. Security..... 3
  - 1.2. Intended use.....3
  - 1.3. Personnel qualification.....3
  - 1.4. Signage, safety labels, type plate..... 4
- 2. Transport, packaging and storage..... 4
- 3. Commisioning..... 4
  - 3.1. Assambly..... 4
  - 3.2. Requirements for achieving the protection class (IP 65)..... 4
  - 3.3. Drilling template ..... 4
  - 3.4. Pin assignment.....5
  - 3.5. Maintenance ..... 5
  - 3.6. Disposal ..... 5
- 4. Technical data and assembly instructions.....6
- 5. Characteristics.....10

HP / CK 25.06.2024

---

## Testo Sensor GmbH

Testo-Straße 1  
D-79853 Lenzkirch

+49 7653 96597-71

webshop@testo-sensor.de

Please find our whole temperature probe and transmitter portfolio in our webshop at: [www.testo-sensor.shop](http://www.testo-sensor.shop)

Managing Director: Prof. Burkart Knospe, Martin Arndt, Timo Löffler

Amtsgericht Freiburg HRB 706025 | Umsatzsteuer-ID.: DE274417683

## 1. General

- The temperature probe described in the operating instructions is manufactured according to the current state of the art. All components are subject to strict quality and environmental criteria during manufacture. Our management systems are certified according to ISO 9001 and ISO 14001. The general terms and conditions in the sales documents apply, subject to technical changes.
- These operating instructions are an important part of the product. It must be available to qualified personnel and must be carefully read and understood before starting any work. Please be sure to comply with all the safety and handling instructions given. In particular, observe the local accident prevention regulations and general safety regulations applicable to the area of use of the product.
- The manufacturer's liability expires in the event of damage caused by improper use, non-observance of the instructions, use of insufficiently qualified personnel and unauthorised modifications to the product.

### 1.1. Security

**WARNING! Before installation, commissioning and operation, please make absolutely sure that the correct temperature probe has been selected with regard to design and specific measuring conditions. Failure to do so may result in serious personal injury and/or damage to property.**

- The selection of the products and, in particular, the determination of their suitability for a specific purpose are the sole responsibility of the purchaser, who must also ensure that incorrect planning, operation or installation does not cause any further damage and that compliance with the relevant construction and safety guidelines is observed and guaranteed.
- No liability or warranty is expressly accepted for damage caused by incorrect planning, operation, installation or malfunction of the products.
- The technical data and connection conditions in the supplied installation and operating instructions apply exclusively. Changes are possible in the interests of technical progress and the continuous improvement of our products.

### 1.2. Intended use

- For the intended use of the probe, please refer to the technical data and the commissioning instructions in the operating instructions. The product is designed and built exclusively for the intended use described there and may only be used accordingly. The technical specifications must be observed. Claims due to improper use are excluded.
- This product must not be used for safety-relevant tasks, such as monitoring or protecting persons against danger or injury, as an emergency stop switch on systems or machines, etc.
- This type of temperature probe has been developed, qualified and manufactured to the highest quality standards. Application-specific environmental or stress conditions can influence the behaviour and lead to deviations from the specifications in the data sheet. To avoid this, we recommend application-specific advice.

**Application-specific environmental or stress conditions can be in particular:**

- Ingress of humidity, which can lead to falsification of measured values
- Vibration, which causes high acceleration forces
- UV irradiation, which can lead to embrittlement of the cable insulation
- Tensile forces acting on the cable, which can damage the probe's internal structure
- Insufficient thermal coupling to the measured medium, with increased response times as a result
- impact with excessively high temperatures, which can change or destroy the built-in measuring resistor or electronic components
- corrosion at the cable ends or the connector contacts, so that measured value falsifications can occur

### 1.3. Personnel qualification

**WARNING! - Risk of injury due to insufficient professional qualification! Improper handling can lead to considerable personal injury and damage to property.**

- The activities described in these operating instructions may only be carried out by adequately qualified personnel. Special operating conditions may require additional, appropriate knowledge, e.g. about aggressive media, possible dangers or country-specific regulations, standards or guidelines. Please keep unqualified personnel away from the danger areas.

## 1.4. Signage, safety labels, type plate

Products are labelled as follows. (Exemplary representation)

Label for temperature probes with housing/head



Label for cable probes (attached to the cable as a flag)

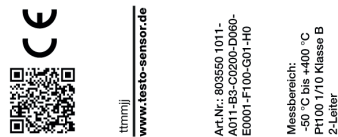

## 2. Transport, packaging and storage

**Transport:** Please inspect the product for any transport damage immediately after delivery. Please notify us immediately of any obvious damage.

**Packaging:** Please remove the packaging only immediately before assembly and keep it, as the packaging provides optimum protection during transport.

**Storage:** The permissible storage temperature is -20 ... +70 °C and the ambient humidity conditions at the storage location should preferably be approx. 20% ... 85% relative humidity; condensation should be avoided.

**The following influences should be avoided:**

- Direct sunlight or proximity to hot objects
- Mechanical vibration, mechanical shock (hard impact)
- Exposure to soot, steam, dust or corrosive gases
- Explosive environment, flammable atmospheres

**Original packaging: Please store the product in the original packaging in a place that meets the conditions listed above. If the original packaging is not available, please pack and store the product as follows:**

- Wrap the product in an antistatic plastic sheet.
- Place the product with the insulation material in the packaging.
- For longer storage (more than 30 days), add a bag of desiccant to the packaging.

## 3. Commissioning

### 3.1. Assembly

- The products may only be connected in a de-energised state, only to safety extra-low voltages and only by suitably qualified personnel.
- Please observe the safety regulations of the VDE, the federal states, their monitoring bodies, the TÜV and the local EVU. The installation instructions in the data sheet must be observed.
- Please observe EMC guidelines to prevent damage, faults on the product or measured value deviations.

### 3.2. Requirements for achieving the protection class (IP 65)

- Only use the cable gland in the specified clamping range (select the cable Ø to match the cable gland).
- Do not use the lower clamping area when using very soft cable types.
- Only use round cables (a slightly oval cross-section may also be suitable).
- Do not twist the cable.
- Multiple opening/closing is possible, but can have a negative effect on the protection class.
- For cables with pronounced cold flow behaviour, please tighten the screw connection if necessary.

### 3.3. Drilling template

You will find the drilling template, if available, in the technical data.

### 3.4. Pin assignment

The characteristics of our sensors can be found on our website or in the appendix to these operating instructions.

- The products are designed for operation on safety extra-low voltages (SELV).
- For the electrical connection of the products, the technical data of the products apply.
- Especially for passive probes (e.g. Pt100 etc.) in a two-wire circuit, the lead resistance of the supply line must be taken into account in order to correct measured value deviations (offset).
- If necessary, the lead resistance must be corrected in the subsequent electronics.
- Due to self-heating, the measuring current influences the measuring accuracy. Therefore, the measuring current should not be greater than 1 mA.

#### Wiring diagram

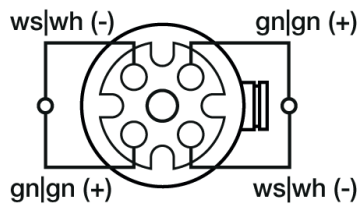

### 3.5. Maintenance

The product is maintenance-free. Repairs may only be carried out by the manufacturer or by qualified personnel.

### 3.6. Disposal

The product is to be classified as electrical and electronic equipment, so that it must be disposed of as electrical / electronic waste. Alternatively, you can return the product to us for proper disposal. The product should not be disposed of as household waste. Special treatment for special components may be legally mandatory and ecologically sensible. Please also observe the local legislation applicable to disposal.

## 4. Technical data and assembly instructions

### Double thermocouple Type K with J-Head - OH

Article no.805017 1211

Our screw-in double thermocouple type K with J-head - OH is suitable for use up to 800 °C and is installed via the G1/2 " thread. It has two built-in thermocouples. This allows you to operate two different evaluation units, for example, or to increase reliability in safety-relevant processes. In more complicated installation situations, you can simply switch to the second thermocouple instead of removing the probe. The J-head with the protection sleeve without neck tube is designed according to DIN43772 Form 8.



General Information	
Measuring range	-40 °C to +800 °C
Perm. (°C) conn. head	-40 °C to +100 °C
Accuracy	-40 °C to +375 °C: ±1,5 °C   375 °C to 1.000 °C: ±0,004  t  according to DIN IEC 60584 Class 1
Supply and output	
Measuring element	2 x Thermocouple Type K
Measuring point	Measuring point isolated
Measurement signal	Thermovoltage
Ambient conditions	
Protection class	IP54 according DIN 60529
Humidity and moisture condensation resistance	according to application-specific qualification
Certificates and Standards	
Standards	DIN EN 61326-1:2013   DIN EN IEC 63000:2019-05
Directive	RoHS 2011/65/EU   2014/30/EU

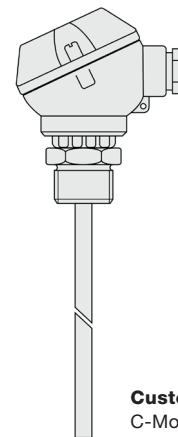

Customizable options  
C-Mounting length

Connection head	
Design	Form J (MA)
Material	Aluminium pressure die-casting
W/H/Ø (mm)	50/60/48
Color	RAL 9006 aluminium silver
Cable gland head	with strain relief
Cable electrical connection	Screw terminals max. 1,5 mm <sup>2</sup>
Clamping range (mm)	5 to 9
Ambient temperature max	+100 °C
Sensor unit	Fixed

Screw-in thread		Your order code	C - Mounting length		
Material	Stainless steel 1.4571   316TI	Article no.	Code	Length (mm)	
Length (mm)	14				
Process connection	G1/2 "	805017 1211	C_	C0050	50 <sup>1)</sup>
Wrench size	27			C0100	100 <sup>1)</sup>
<b>Protection sleeve</b>				C0150	150 <sup>1)</sup>
Material	Stainless steel 1.4571   316TI			C0200	200 <sup>1)</sup>
Mounting length (mm)	please choose			C0250	250 <sup>1)</sup>
Ø (mm)	6 <sup>2)</sup>			C0300	300 <sup>1)</sup>
				C0400	400 <sup>1)</sup>
				C0500	500 <sup>1)</sup>

Other mounting lengths on request | <sup>1)</sup>Tolerance ± 1% | <sup>2)</sup> Tolerance ± 0,1 mm

HP / CK 25.06.2024

### Testo Sensor GmbH

+49 7653 96597-71

Testo-Straße 1  
D-79853 Lenzkirch

webshop@testo-sensor.de

Managing Director: Prof. Burkart Knospe, Martin Arndt, Timo Löffler

Amtsgericht Freiburg HRB 706025 | Umsatzsteuer-ID.: DE274417683

Please find our whole temperature probe and transmitter portfolio in our webshop at: [www.testo-sensor.shop](http://www.testo-sensor.shop)

Delivery and Assembly	
Assembly instructions	by means of process connection
Delivery and Packaging	Probe, separately packaged in PE bag
Important assembly advices	
<p>Measuring errors can occur due to heat dissipation to the environment. To keep these as small as possible, we recommend immersing the protection sleeve of your temperature probe as deep as possible into the medium to be measured during installation. The optimum installation depth should be 10-15 times the <math>\varnothing</math> of the protection sleeve or, if an immersion sleeve is used, the <math>\varnothing</math> of the immersion sleeve. When installing in pipes whose <math>\varnothing</math> does not have a sufficiently deep installation depth, you should either install the probe at an angle or in a pipe elbow. Make sure that you have enough space so that the probe can be removed again. 1) Installation with sufficient installation depth 2) Installation at an angle with small pipe <math>\varnothing</math> 3) Not like this: Minimum installation depth not reached</p>	
<p>Installation by using an immersion sleeve (4): Please ensure that the <math>\varnothing</math> and length of the immersion sleeve are selected to suit the installation situation so that the minimum immersion depth can be achieved. Please also ensure that the process connection is correct. Because the probe is not inserted directly into the medium, but via the immersion sleeve, the response times are somewhat slower. The probe should be selected so that the protection sleeve touches the bottom of the immersion sleeve and the air cushion around the protection tube is as small as possible. The use of thermal conduction paste can improve the response times.</p>	
<p>Please lay the cable so that no water can penetrate the probe and with a spare loop (4). This allows you to extend the probe without disconnecting the electrical connection.</p>	

Technical drawing		
Customizable options	C - Mounting length	All dimensions in mm

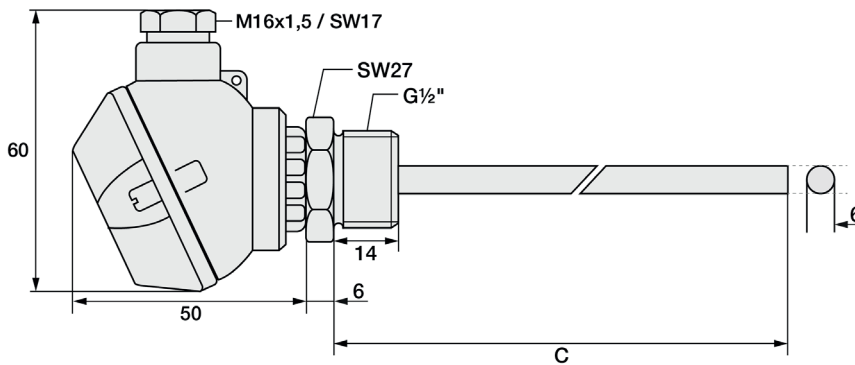

HP / CK 25.06.2024

**Testo Sensor GmbH**

+49 7653 96597-71  
 Testo-Straße 1  
 D-79853 Lenzkirch

Managing Director: Prof. Burkart Knospe, Martin Arndt, Timo Löffler  
 webshop@testo-sensor.de  
 Amtsgericht Freiburg HRB 706025 | Umsatzsteuer-ID.: DE274417683  
 Please find our whole temperature probe and transmitter portfolio in our webshop at: [www.testo-sensor.shop](http://www.testo-sensor.shop)

## Matching accessories: Heat-conducting paste

Heat-conducting paste		
	<b>Article no.</b>	<b>809540 1000</b>
	Content	10 ml
	Thermal conductivity	>2.5 W/mK
	Min / Max °C	-30 °C to +280 °C
	Thermal resistance	< 0.126

HP / CK 25.06.2024

### Testo Sensor GmbH

Testo-Straße 1  
D-79853 Lenzkirch

+49 7653 96597-71

webshop@testo-sensor.de

Please find our whole temperature probe and transmitter portfolio in our webshop at: [www.testo-sensor.shop](http://www.testo-sensor.shop)

Managing Director: Prof. Burkart Knospe, Martin Arndt, Timo Löffler

Amtsgericht Freiburg HRB 706025 | Umsatzsteuer-ID.: DE274417683



## Matching accessories: Immersion sleeves

Immersion sleeves		Please select Ø and mounting length and append the codes to your order code.				
Picture	Immersion sleeve G1/2 " with internal thread		Code	Ø Inside / Outside (mm)	Code	ML (mm)
	Article no.	809520 3XXX				
	Temp. Max	+600 °C				
	pressure proof until	40 bar	1	6,5 / 9	03	30
	Material	Stainless steel 1.4571   316TI	2	7,5 / 10	08	80
	Process connection	G1/2 "	3	8,5 / 11	13	130
	Wrench size	27	4	9,5 / 12	18	180
	Screw-in thread	G1/2 "			23	230
	Scope of delivery	Immersion sleeve, packed in PE bag			28	280
					38	380
Your order code	809520 3	-		--		

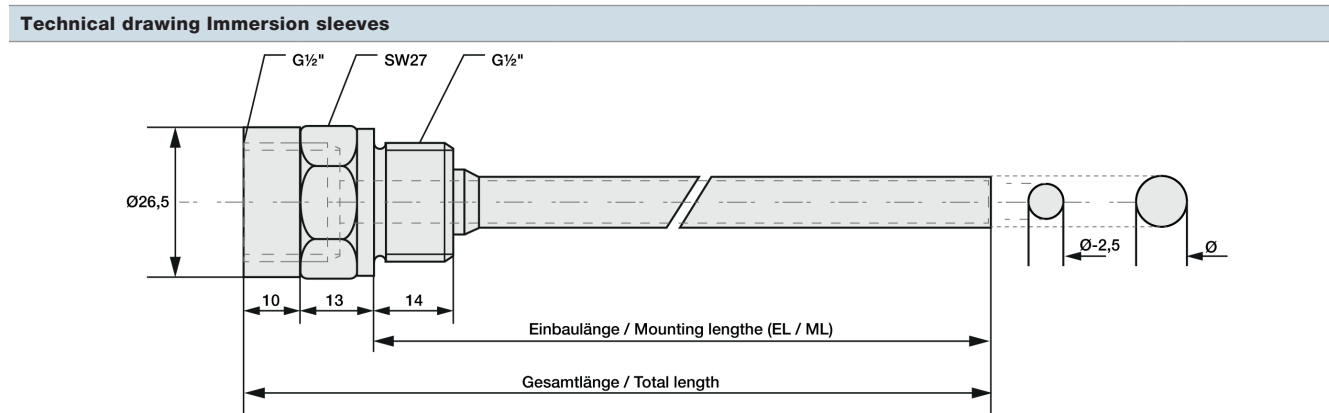

HP / CK 25.06.2024

## 5. Characteristics

HP / CK 25.06.2024

---

### Testo Sensor GmbH

Testo-Straße 1  
D-79853 Lenzkirch

+49 7653 96597-71  
webshop@testo-sensor.de  
Please find our whole temperature probe and transmitter portfolio in our webshop at: [www.testo-sensor.shop](http://www.testo-sensor.shop)

Managing Director: Prof. Burkart Knospe, Martin Arndt, Timo Löffler  
Amtsgericht Freiburg HRB 706025 | Umsatzsteuer-ID.: DE274417683

# Characteristic Thermocouple Type K

Measuring range: -40 °C to +1.200 °C

Accuracy class Thermocouple Type K according DIN IEC 60584	
Class	Formula
Cl. 1	-40 °C to +375 °C: ±1,5 °C   +375 °C to +1.000 °C: ±0,004  t
Cl. 2	-40 °C to +333 °C: ±2,5 °C   +333 °C to +1.200 °C: ±0,0075  t

Example values		
Value @ T = 100 °C	Value @ T = 500 °C	Value @ T = 1.000 °C
±1,5 °C	±2,00 °C	±4,0 °C
± 2,5 °C	±3,75 °C	±7,5 °C

Type K T in °C	EMF* in µV	Max. tol. ± in °C**	
		Cl. 1	Cl. 2
-270	-6.458		
-260	-6.441		
-250	-6.404		
-240	-6.344		
-230	-6.262		
-220	-6.158		
-210	-6.035		
-200	-5.891		
-190	-5.730		
-180	-5.550		
-170	-5.354		
-160	-5.141		
-150	-4.913		
-140	-4.669		
-130	-4.411		
-120	-4.138		
-110	-3.852		
-100	-3.554		
-90	-3.243		
-80	-2.920		
-70	-2.587		
-60	-2.243		
-50	-1.889		
-40	-1.527	1,5	2,5
-30	-1.156	1,5	2,5
-20	-778	1,5	2,5
-10	-392	1,5	2,5
0	0	1,5	2,5
10	397	1,5	2,5
20	798	1,5	2,5
30	1.203	1,5	2,5
40	1.612	1,5	2,5
50	2.023	1,5	2,5
60	2.436	1,5	2,5
70	2.851	1,5	2,5
80	3.267	1,5	2,5

Type K T in °C	EMF* in µV	Max. tol. ± in °C**	
		Cl. 1	Cl. 2
90	3.682	1,5	2,5
100	4.096	1,5	2,5
110	4.509	1,5	2,5
120	4.920	1,5	2,5
130	5.328	1,5	2,5
140	5.735	1,5	2,5
150	6.138	1,5	2,5
160	6.540	1,5	2,5
170	6.941	1,5	2,5
180	7.340	1,5	2,5
190	7.739	1,5	2,5
200	8.138	1,5	2,5
210	8.539	1,5	2,5
220	8.940	1,5	2,5
230	9.343	1,5	2,5
240	9.747	1,5	2,5
250	10.153	1,5	2,5
260	10.561	1,5	2,5
270	10.971	1,5	2,5
280	11.382	1,5	2,5
290	11.795	1,5	2,5
300	12.209	1,5	2,5
310	12.624	1,5	2,5
320	13.040	1,5	2,5
330	13.457	1,5	2,5
340	13.874	1,5	2,6
350	14.293	1,5	2,6
360	14.713	1,5	2,7
370	15.133	1,5	2,8
380	15.554	1,5	2,9
390	15.975	1,6	2,9
400	16.397	1,6	3,0
410	16.820	1,6	3,1
420	17.243	1,7	3,2
430	17.667	1,7	3,2
440	18.091	1,8	3,3

Type K T in °C	EMF* in µV	Max. tol. ± in °C**	
		Cl. 1	Cl. 2
450	18.516	1,8	3,4
460	18.941	1,8	3,5
470	19.366	1,9	3,5
480	19.792	1,9	3,6
490	20.218	2,0	3,7
500	20.644	2,0	3,8
510	21.071	2,0	3,8
520	21.497	2,1	3,9
530	21.924	2,1	4,0
540	22.350	2,2	4,1
550	22.776	2,2	4,1
560	23.203	2,2	4,2
570	23.629	2,3	4,3
580	24.055	2,3	4,4
590	24.480	2,4	4,4
600	24.905	2,4	4,5
610	25.330	2,4	4,6
620	25.755	2,5	4,7
630	26.179	2,5	4,7
640	26.602	2,6	4,8
650	27.025	2,6	4,9
660	27.447	2,6	5,0
670	27.869	2,7	5,0
680	28.289	2,7	5,1
690	28.710	2,8	5,2
700	29.129	2,8	5,3
710	29.548	2,8	5,3
720	29.965	2,9	5,4
730	30.382	2,9	5,5
740	30.798	3,0	5,6
750	31.213	3,0	5,6
760	31.628	3,0	5,7
770	32.041	3,1	5,8
780	32.453	3,1	5,9
790	32.865	3,2	5,9
800	33.275	3,2	6,0

Type K T in °C	EMF* in µV	Max. tol. ± in °C**	
		Cl. 1	Cl. 2
810	33.685	3,2	6,1
820	34.093	3,3	6,2
830	34.501	3,3	6,2
840	34.908	3,4	6,3
850	35.313	3,4	6,4
860	35.718	3,4	6,5
870	36.121	3,5	6,5
880	36.524	3,5	6,6
890	36.925	3,6	6,7
900	37.326	3,6	6,8
910	37.725	3,6	6,8
920	38.124	3,7	6,9
930	38.522	3,7	7,0
940	38.918	3,8	7,1
950	39.314	3,8	7,1
960	39.708	3,8	7,2
970	40.101	3,9	7,3
980	40.494	3,9	7,4
990	40.885	4,0	7,4
1.000	41.276	4,0	7,5
1.010	41.665		7,6
1.020	42.053		7,7
1.030	42.440		7,7
1.040	42.826		7,8
1.050	43.211		7,9
1.060	43.595		8,0
1.070	43.978		8,0
1.080	44.359		8,1
1.090	44.740		8,2
1.100	45.119		8,3
1.110	45.497		8,3
1.120	45.873		8,4
1.130	46.249		8,5
1.140	46.623		8,6
1.150	46.995		8,6
1.160	47.367		8,7

HP / CK 25.06.2024

**Testo Sensor GmbH**

+49 7653 96597-71

Testo-Straße 1  
D-79853 Lenzkirch

webshop@testo-sensor.de

Managing Director: Prof. Burkart Knospe, Martin Arndt, Timo Löffler

Amtsgericht Freiburg HRB 706025 | Umsatzsteuer-ID.: DE274417683

Please find our whole temperature probe and transmitter portfolio in our webshop at: [www.testo-sensor.shop](http://www.testo-sensor.shop)

Type K T in °C	EMF* in µV	Max. tol. ± in °C**		Type K T in °C	EMF* in µV	Max. tol. ± in °C**		Type K T in °C	EMF* in µV	Max. tol. ± in °C**		Type K T in °C	EMF* in µV	Max. tol. ± in °C**	
		Cl. 1	Cl. 2			Cl. 1	Cl. 2			Cl. 1	Cl. 2			Cl. 1	Cl. 2
1.170	47.737		8,8	1.230	49.926			1.290	52.060			1.350	54.138		
1.180	48.105		8,9	1.240	50.286			1.300	52.410			1.360	54.479		
1.190	48.473		8,9	1.250	50.644			1.310	52.759			1.370	54.819		
1.200	48.838		9,0	1.260	51.000			1.320	53.106						
1.210	49.202			1.270	51.355			1.330	53.451						
1.220	49.565			1.280	51.708			1.340	53.795						

\*Thermoelectric voltage (EMF) in µV

\*\*Maximum tolerance according DIN IEC 60584

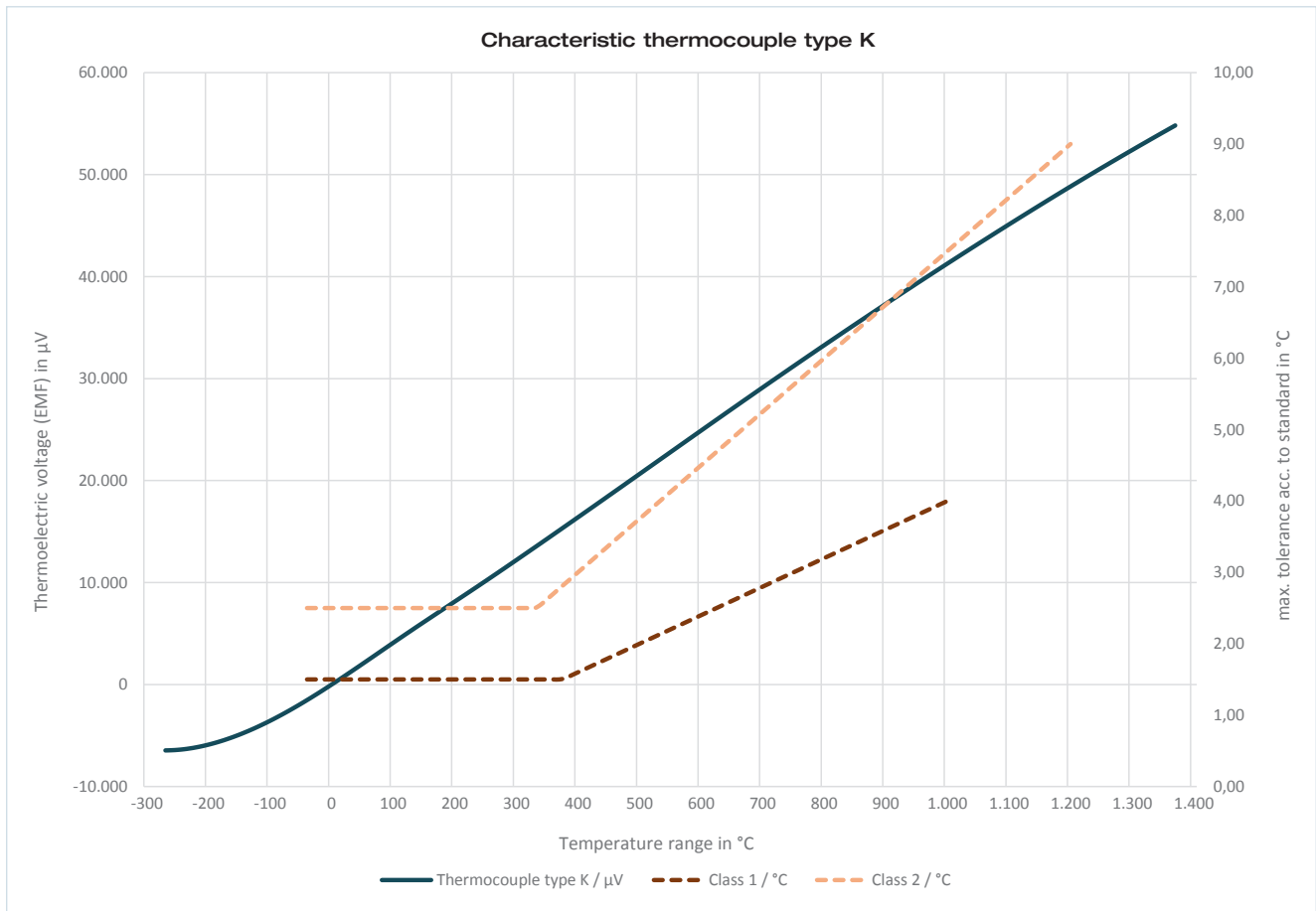

The standard specifies measuring ranges for thermocouples in which the respective measuring accuracy of the tolerance class applies. For use outside this specified measuring range, it is not possible to specify the measuring accuracy. If the thermocouple is operated outside the specified measuring range of its respective tolerance class, irreversible damage to the thermocouple may occur, which will result in a measurement deviation (even within the specified range). Use beyond the measuring range of the tolerance class represents misuse and leads to a loss of warranty.

HP / CK 25.06.2024

**Testo Sensor GmbH**  
**Testo-Strasse 1**  
**79853 Lenzkirch**

**Phone: +49 7653 96597 0**  
**Fax: +49 7653 96597 99**  
**E-mail: [info@testo-sensor.de](mailto:info@testo-sensor.de)**

**Handelsregister: HRB 706025**  
**Registergericht: Amtsgericht Freiburg**

HP / CK 25.06.2024

All rights reserved. Changes to the documents are not authorised.  
We reserve the right to make technical changes.  
Please read the operating instructions before starting any work.